

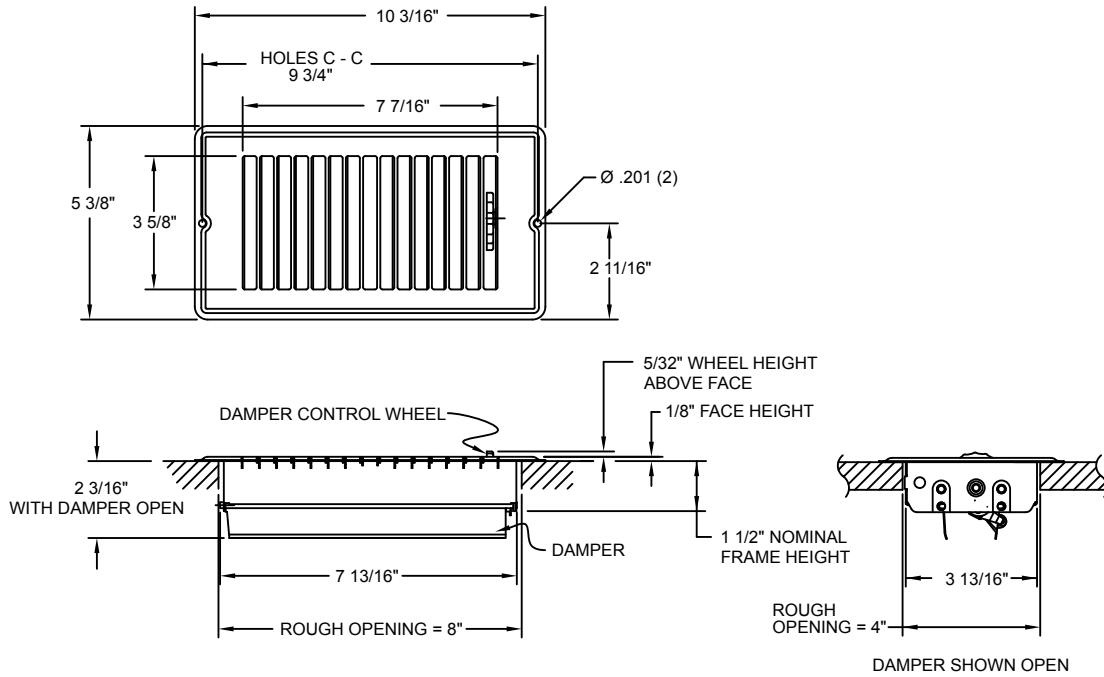

Metaline (brand)
 Continental Industries, Inc.
 100 West Windsor Avenue
 Elkhart, Indiana 46514
 Phone: 800.735.5272 • Fax: 574.262.2075
 Email: info@continentalindustries.com
 Web: www.continentalindustries.com

Submittal Drawing & Form



Description
<input type="checkbox"/> Packaging: Bulk
<input type="checkbox"/> Mounting holes
<input type="checkbox"/> Opposed blade damper
<input type="checkbox"/> Construction: Steel
<input type="checkbox"/> Finish: Anodic Acrylic Electrocoat
<input type="checkbox"/> Color: White
<input type="checkbox"/> Origin: Made in the U.S.A.
<input type="checkbox"/> Carton quantity: 24

Project Details	Submitted by:	LS248W Extended Face Floor Register
Job Title:	Date:	
Location:		
Architect:		
Engineer:		
Contractor:		
		SD-LS248W-01