

Series AVM Sidewall/Ceiling Supply Diffuser

- Adjustable, vertical, roll-form face bars
- 3/4" bar spacing for easy adjustment
- Single deflection
- Multi-shutter damper
- Aluminum construction
- White finish
- Made in the U.S.A.

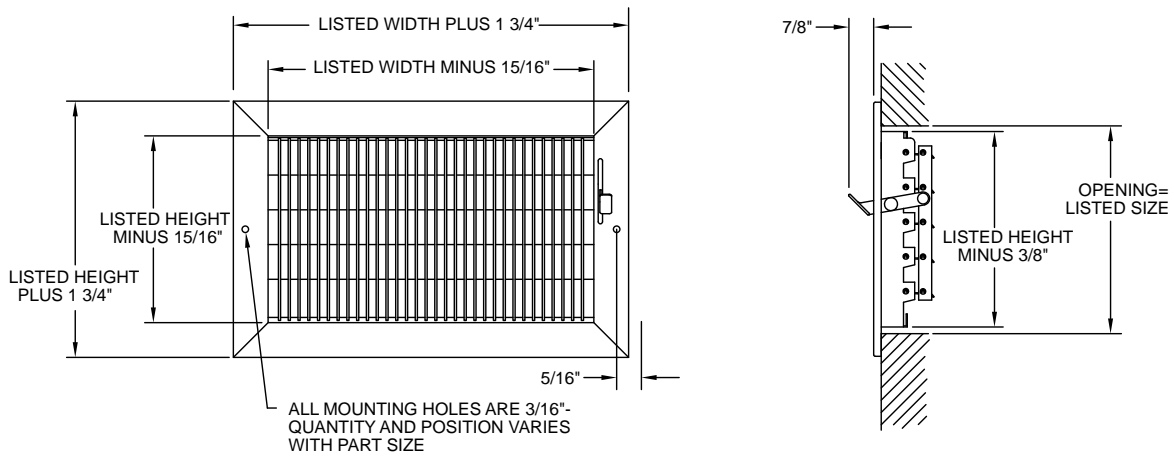

Dimensional Drawings



DAMPERS SHOWN OPEN, ALL VIEWS

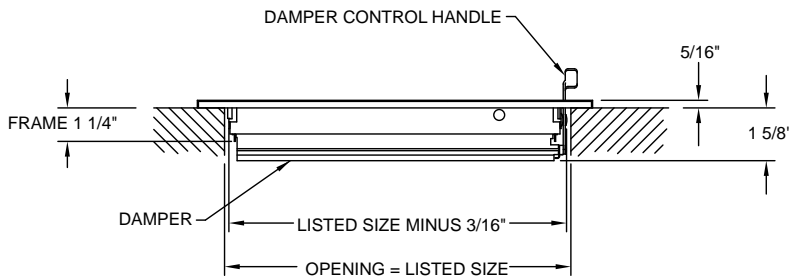

Appearance Note

Any models with a dimension larger than 16" require two or more damper boxes and associated reinforcement face bars.

Performance Data, Series AVM

Unit Size (in.)	Overall Size (in.)	Face Velocity	300	400	500	600	700	800	900	1000
			Pressure Loss	.006	.010	.016	.022	.031	.040	.050
6 x 6 Ak .139	7-3/4 x 7-3/4	Cfm	42	56	69	83	97	111	125	139
		Throw	5	6	7	9	10	12	13	15
8 x 4 Ak .118	9-3/4 x 5-3/4	Cfm	35	47	59	71	83	94	106	118
		Throw	4	5	7	8	9	11	12	13
8 x 6 Ak .188	9-3/4 x 7-3/4	Cfm	56	75	94	113	131	150	169	188
		Throw	5	7	8	10	12	14	15	17
8 x 8 Ak .257	9-3/4 x 9-3/4	Cfm	77	103	128	154	180	206	231	257
		Throw	6	7	9	11	13	15	17	19

NC ≤30 NC 35

Performance Data, Series AVM (continued)

Unit Size (in.)	Overall Size (in.)	Face Velocity	300	400	500	600	700	800	900	1000
		Pressure Loss	.006	.010	.016	.022	.031	.040	.050	.062
10 x 4 Ak .146	11-3/4 x 5-3/4	Cfm	44	58	73	88	102	117	131	146
		Throw	5	6	8	9	11	12	13	14
10 x 6 Ak .236	11-3/4 x 7-3/4	Cfm	71	94	118	142	165	189	213	236
		Throw	6	8	9	11	13	15	17	19
10 x 8 Ak .326	11-3/4 x 9-3/4	Cfm	98	131	163	196	228	261	294	326
		Throw	7	8	10	12	14	16	17	21
10 x 10 Ak .417	11-3/4 x 11-3/4	Cfm	125	167	208	250	292	333	375	417
		Throw	7	9	12	14	16	18	20	23
12 x 4 Ak .181	12-3/4 x 5-3/4	Cfm	54	72	90	108	126	144	163	181
		Throw	5	7	8	10	12	14	15	17
12 x 6 Ak .285	13-3/4 x 7-3/4	Cfm	85	114	142	171	199	228	256	285
		Throw	7	8	10	12	15	17	19	21
12 x 8 Ak .389	13-3/4 x 9-3/4	Cfm	117	156	194	233	272	311	350	389
		Throw	7	9	11	13	18	17	19	22
12 x 12 Ak .611	13-3/4 x 13-3/4	Cfm	183	244	306	367	428	489	550	611
		Throw	9	11	14	17	20	22	25	29
14 x 4 Ak .208	15-3/4 x 5-3/4	Cfm	63	83	104	125	146	167	188	208
		Throw	5	7	9	11	13	15	17	18
14 x 6 Ak .313	15-3/4 x 7-3/4	Cfm	94	125	156	188	219	250	281	313
		Throw	7	8	11	13	16	18	20	23
14 x 8 Ak .458	15-3/4 x 9-3/4	Cfm	138	183	229	275	321	367	413	458
		Throw	8	9	12	14	17	19	21	24
14 x 14 Ak .840	15-3/4 x 15-3/4	Cfm	252	336	420	504	588	672	756	840
		Throw	9	15	19	23	27	31	34	38

Terminal Velocity of 75 fpm

NC ≤30
 NC 35

Mounting Hole Guide for Select Products

The following products in this section have embossed (recessed) mounting holes.

Series	Page #
RVML & AVM	122, 127
RHML & AHM	129, 131
RGV & ARGV	133
RGV-0 & ARVG-0	135
RGH & ARGH	137
RGH-0 & ARGH-0	139
HVG & AHVG	141
VHG & AVHG	143
FBG40 & AFBG40	145
FBG60 & AFBG60	147

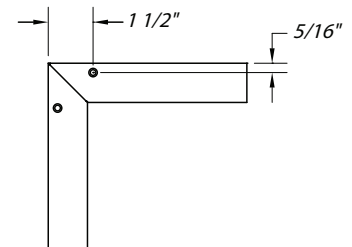
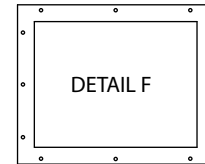
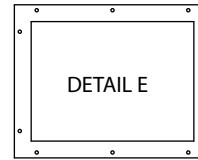
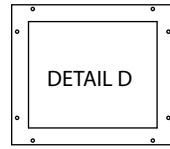
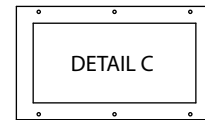
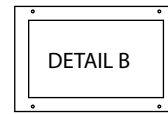
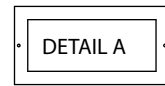

The following chart and diagrams above apply to these products.

		Width																									
		6	8	10	12	14	15	16	18	20	22	24	26	28	30	32	34	36	38	40	42	44	46	48			
Height	4																									4	
	6																										6
	8				A							B															8
	10			2 Holes								4 Holes									C						10
	12																					6 Holes					12
	14																										14
	15																										15
	16																										16
	18																										18
	20																										20
	22				B								D									E					22
	24			4 Holes									8 Holes									10 Holes					24
	26																										26
	28																										28
	30																										30
	32																										32
	34																										34
	36																										36
38				C								E									F					38	
40			6 Holes									10 Holes									12 Holes					40	
42																										42	
44																										44	
46																										46	
48																										48	
		6	8	10	12	14	15	16	18	20	22	24	26	28	30	32	34	36	38	40	42	44	46	48			
		Width																									

Commercial
Sidewall or Ceiling