

Series RGV/ARGV Sidewall/Ceiling Supply Grille

- Adjustable, vertical, roll-form face bars
- 3/4" bar spacing for easy adjustment
- Single deflection
- Steel construction (RGV)
- Aluminum construction (ARGV)
- White finish
- Made in the U.S.A.

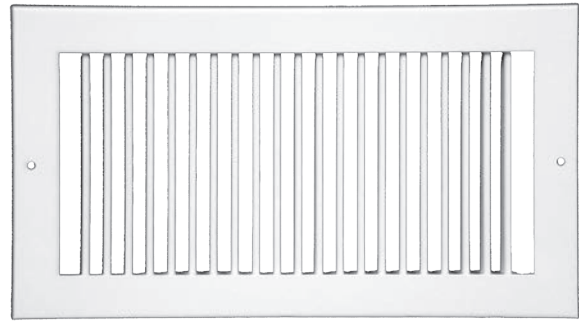

Dimensional Drawings

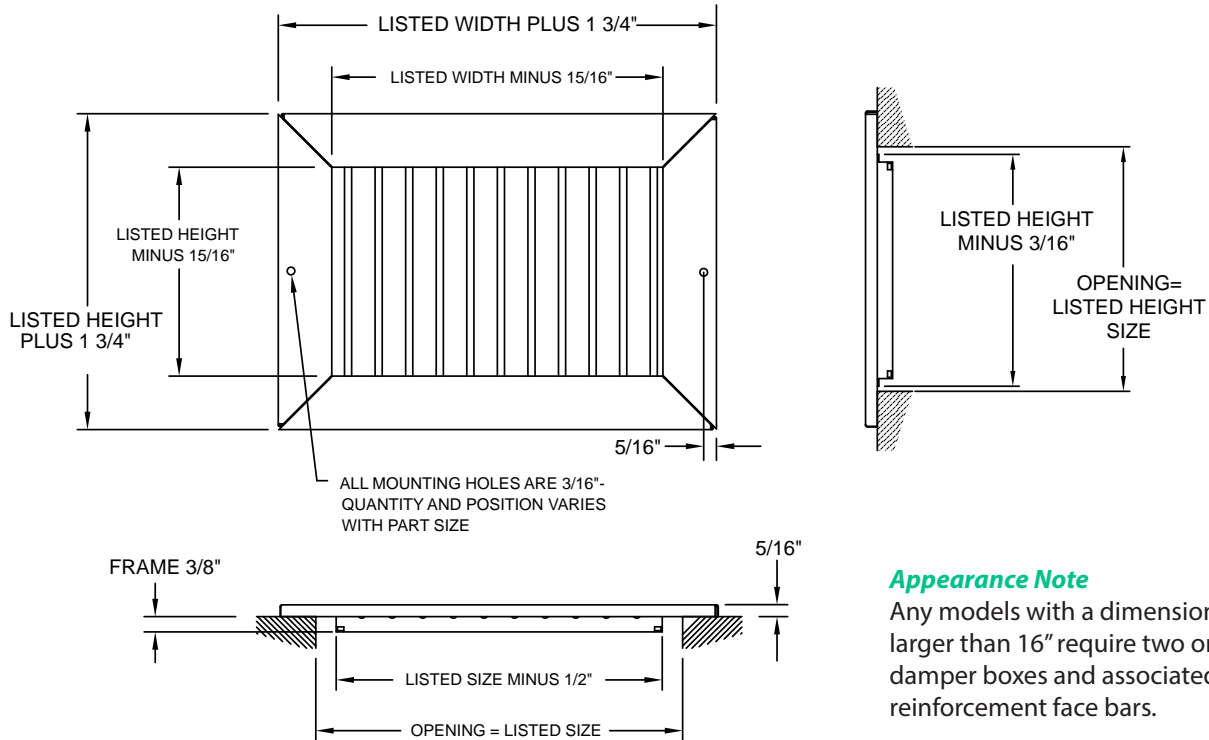

Appearance Note

Any models with a dimension larger than 16" require two or more damper boxes and associated reinforcement face bars.

Performance Data, Series RGV/ARGV

Unit Size (in.)	Overall Size (in.)	Face Velocity	300	400	500	600	700	800	900	1000
		Pressure Loss	.006	.010	.016	.022	.031	.040	.050	.062
6 x 6 Ak .139	7-3/4 x 7-3/4	Cfm	42	56	69	83	97	111	125	139
		Throw	5	6	7	9	10	12	13	15
8 x 8 Ak .257	9-3/4 x 9-3/4	Cfm	77	103	128	154	180	206	231	257
		Throw	6	7	9	11	13	15	17	19
10 x 6 Ak .236	11-3/4 x 7-3/4	Cfm	71	94	118	142	165	189	213	236
		Throw	6	8	9	11	13	15	17	19
10 x 8 Ak .326	11-3/4 x 9-3/4	Cfm	98	131	163	196	228	261	294	326
		Throw	7	8	10	12	14	16	17	21
10 x 10 Ak .417	11-3/4 x 11-3/4	Cfm	125	167	208	250	292	333	375	417
		Throw	7	9	12	14	16	18	20	23

NC ≤30 NC 35

Performance Data, Series RGV/ARGV (continued)

Unit Size (in.)	Overall Size (in.)	Face Velocity	300	400	500	600	700	800	900	1000
		Pressure Loss	.006	.010	.016	.022	.031	.040	.050	.062
12 x 6 Ak .285	13-3/4 x 7-3/4	Cfm	85	114	142	171	199	228	256	285
		Throw	7	8	10	12	15	17	19	21
12 x 8 Ak .389	13-3/4 x 9-3/4	Cfm	117	156	194	233	272	311	350	389
		Throw	7	9	11	13	18	17	19	22
12 x 12 Ak .611	13-3/4 x 13-3/4	Cfm	183	244	306	367	428	489	550	611
		Throw	9	11	14	17	20	22	25	29
14 x 6 Ak .313	15-3/4 x 7-3/4	Cfm	94	125	156	188	219	250	281	313
		Throw	7	8	11	13	16	18	20	23
14 x 8 AK .458	15-3/4 x 9-3/4	Cfm	138	183	229	275	321	367	413	458
		Throw	8	9	12	14	17	19	21	24
14 x 12 Ak .715	15-3/4 x 13-3/4	Cfm	215	286	358	429	501	572	644	715
		Throw	9	12	14	18	22	24	27	31
14 x 14 Ak .840	15-3/4 x 15-3/4	Cfm	252	336	420	504	588	672	756	840
		Throw	9	15	19	23	27	31	34	38
16 x 16 Ak .986	17-3/4 x 17-3/4	Cfm	296	394	493	592	690	789	888	986
		Throw	12	15	20	23	28	31	33	39
18 x 12 Ak .882	19-3/4 x 13-3/4	Cfm	265	353	441	529	617	706	794	882
		Throw	7	10	12	15	17	20	22	25
18 x 18 AK 1.271	19-3/4 x 19-3/4	Cfm	381	508	635	763	890	1017	1144	1271
		Throw	7	10	12	15	17	20	22	25
20 x 14 Ak 1.160	21-3/4 x 15-3/4	Cfm	348	464	580	696	812	928	1044	1160
		Throw	7	10	12	15	17	20	22	25
20 x 20 AK 1.597	21-3/4 x 21-3/4	Cfm	479	639	799	958	1118	1278	1438	1597
		Throw	7	10	12	15	17	20	22	25
24 x 8 Ak .771	25-3/4 x 9-3/4	Cfm	231	308	385	463	540	617	694	771
		Throw	10	13	17	19	23	25	28	31
24 x 10 Ak .979	25-3/4 x 11-3/4	Cfm	294	392	490	588	685	783	881	979
		Throw	7	10	12	15	17	20	22	25
24 x 12 AK 1.403	25-3/4 x 13-3/4	Cfm	358	478	597	717	836	956	1075	1194
		Throw	7	10	12	15	17	20	22	25
24 x 24 Ak 2.354	25-3/4 x 25-3/4	Cfm	706	942	1177	1413	1648	1883	2119	2354
		Throw	7	10	12	15	17	20	22	25
30 x 8 Ak .972	31-3/4 x 9-3/4	Cfm	292	389	486	583	681	778	875	972
		Throw	12	15	20	23	28	31	33	39
30 x 10 Ak 1.236	31-3/4 x 11-3/4	Cfm	371	494	618	742	865	989	1113	1236
		Throw	7	10	12	15	17	20	22	25
30 x 12 Ak 1.500	31-3/4 x 13-3/4	Cfm	450	600	750	900	1050	1200	1350	1500
		Throw	7	10	12	15	17	20	22	25
30 x 14 Ak 1.771	31-3/4 x 15-3/4	Cfm	531	708	885	1063	1240	1417	1594	1771
		Throw	7	10	12	15	17	20	22	25

NC ≤30 NC 35

Terminal velocity is 75 fpm.

Commercial
Sidewall or Ceiling

Mounting Hole Guide for Select Products

The following products in this section have embossed (recessed) mounting holes.

Series	Page #
RVML & AVM	122, 127
RHML & AHM	129, 131
RGV & ARGV	133
RGV-0 & ARVG-0	135
RGH & ARGH	137
RGH-0 & ARGH-0	139
HVG & AHVG	141
VHG & AVHG	143
FBG40 & AFBG40	145
FBG60 & AFBG60	147

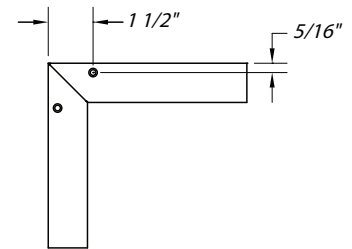
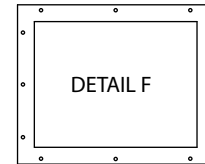
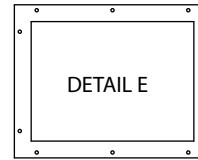
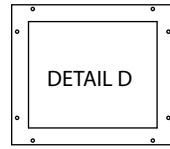
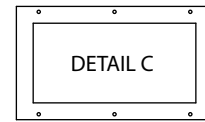
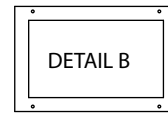
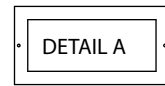

The following chart and diagrams above apply to these products.

		Width																									
		6	8	10	12	14	15	16	18	20	22	24	26	28	30	32	34	36	38	40	42	44	46	48			
Height	4																									4	
	6																										6
	8				A							B															8
	10			2 Holes								4 Holes									C						10
	12																					6 Holes					12
	14																										14
	15																										15
	16																										16
	18																										18
	20																										20
	22				B								D									E					22
	24			4 Holes									8 Holes									10 Holes					24
	26																										26
	28																										28
	30																										30
	32																										32
	34																										34
	36																										36
38				C								E									F					38	
40			6 Holes									10 Holes									12 Holes					40	
42																										42	
44																										44	
46																										46	
48																										48	
		6	8	10	12	14	15	16	18	20	22	24	26	28	30	32	34	36	38	40	42	44	46	48			
		Width																									

Commercial Sidewall or Ceiling